

Melrose 70



FIR BATHROOM A&D

Melrose 70

Gli articoli della collezione Melrose 70 sono disponibili nelle finiture sotto indicate:
 The articles included in Melrose 70 collection are available in the following finishings:
 Die Artikel der Kollektion Melrose 70 sind in folgenden Farben lieferbar:
 Les articles de la collection Melrose 70 sont disponibles dans les exécutions suivantes:
 Los artículos de la colección Melrose 70 están disponibles en los acabados abajo indicados:
 Артикулы коллекции Melrose 70 имеются в указанных ниже цветах:
 在Melrose 70系列里的产品备有下列的颜色:



Chrome

Cromato / Chrome / Chrom / Chromé
 Cromo / Хромированный / 镀铬

Chrome & Black Ceramic

Gold

Oro / Gold / Gold / Or / Oro / Золото / 金色

Antique Gold

Oro Antico / Antique Gold / Antik Gold / Vieil Or
 Oro Viejo / Состаренное золото / 古金色

Antique Gold & Brown Ceramic

Bronze

Ottone Antico / Bronze / Bronziert / Vieux Bronze
 Latón Viejo / Состаренная латунь / 古黄铜色

Chrome & Crystal

glamour®
 styile®
 MADE WITH SWAROVSKI ELEMENTS

Gold & Crystal

glamour®
 styile®
 MADE WITH SWAROVSKI ELEMENTS

Antique Gold & Crystal

glamour®
 styile®
 MADE WITH SWAROVSKI ELEMENTS

Gold Glam

glamour®
 styile®

Gold Glam & Crystal

glamour®
 styile®
 MADE WITH SWAROVSKI ELEMENTS

Bronze & Crystal

glamour®
 styile®
 MADE WITH SWAROVSKI ELEMENTS

DATI TECNICI
 TECHNICAL DATA
 TECHNISCHE DATEN
 DONNEES TECHNIQUES
 DATOS TÉCNICOS
 ТЕХНИЧЕСКИЕ ДАННЫЕ
 技术数据

65° (max 80° C)

Temperatura ottimale acqua calda
 Optimal hot water temperature
 Optimaltemperatur vom warmen Wasser
 Température optimale eau chaude
 Temperatura óptima del agua caliente
 Оптимальная температура горячей воды
 最佳的热水温度

2 bar (min 1 - max 5)

Pressione ottimale di esercizio
 Optimal operational pressure
 Optimaler Betriebsdruck
 Pression optimale de fonctionnement
 Presión óptima de funcionamiento
 Оптимальное рабочее давление
 最佳工作压力

0,1 bar (max 1)

Differenza di pressione acqua calda/fredda
 Hot/cold water pressure difference
 Drucksunterschied vom warmen/kalten Wasser
 Différence de pression eau chaude/froide
 Diferencia de presión del agua caliente/fría
 Разница давления холодной/горячей воды
 冷/热水压力差

AVVERTENZE - REMARKS - ANMERKUNGEN - NOTES - NOTA - ПРЕДУПРЕЖДЕНИЯ - 警告

- Per i miscelatori monocomando FIR ITALIA consiglia l'installazione sulle due mandate di rubinetti filtro ispezionabili (Art. 11.0503.2, 11.0505.2), per trattenere eventuali corpi estranei che potrebbero danneggiare gli organi di tenuta della cartuccia.
- For the single lever mixers FIR ITALIA recommends the assembling of removable filter elbow connections (Art. 11.0503.2, 11.0505.2) in order to avoid possible obstructions or damages to the cartridge caused by deposit conveyed by water.
- Für die Einhebelmischer empfiehlt FIR ITALIA die Montage von Eckreguliventilen (Art. 11.0503.2, 11.0505.2), um eventuelle Fremdkörper aufzuhalten, welche die Kartusche beschädigen können.
- Pour les mitigeurs FIR ITALIA conseille le montage de robinets filtre (Art. 11.0503.2, 11.0505.2), afin de retenir éventuels corps étrangers qui peuvent endommager les cartouches.
- FIR ITALIA aconseja instalar los mezcladores monomando en los dos lados de descarga de los grifos filtro inspeccionable (Art. 11.0503.2, 11.0505.2) para retener los posibles cuerpos extraños que puedan dañar los órganos de estanqueidad del cartucho.
- Для одноручковых смесителей FIR ITALIA рекомендует на двух подающих трубах кранов устанавливать проверяемые фильтры (Art. 11.0503.2, 11.0505.2), для задержания возможных посторонних тел, которые могли бы повредить детали, обеспечивающие герметичность картриджа.
- 对于单把龙头 FIR ITALIA建议装配可卸式滤器的弯接头 (型号11.0503.2, 11.0505.2), 以避免可能出现的障碍物或供水中的沉淀物对阀芯造成损害。

FIR ITALIA si riserva, ogni qualvolta si rendesse necessario, di apportare modifiche tecniche ed estetiche senza obbligo di preavviso. - FIR ITALIA, whenever necessary, reserves itself the right of deciding technical and aesthetical modifications without prior notice. - FIR ITALIA ist ausdrücklich dazu berechtigt, technische und ästhetische Änderungen an ihre einigen Produkte ohne vorherige Mitteilung vorzunehmen. - FIR ITALIA se réserve le droit d'apporter des modifications techniques et esthétiques sans avis préalable. - FIR ITALIA se reserva el derecho, si lo considera necesario, de aportar modificaciones técnicas sin obligación de previo aviso. - FIR ITALIA оставляет за собой право во всех случаях, когда это будет необходимо, вносить технические и эстетические изменения без обязательства производить предварительное уведомление. - FIR ITALIA, 在必要时, 保留技术和外观修改的决定权, 恕不另行通知。

Swarovski® e STRASS® sono marchi commerciali registrati di proprietà della Swarovski AG.
 Swarovski® and STRASS® are registered trademarks of Swarovski AG.

MADE IN ITALY



Area lavabo Wash basin area • Waschtisch-Bereich • Zone du lavabo • Área lavabo • Зона умывальника • 面盆区域	page 333
Area bidet/WC Bidet/WC area • Bidet/WC-Bereich • Zone du bidet/WC • Área bidé/WC • Зона биде/унитаз • 净身盆/厕所区域	page 333
Area vasca/doccia Bath/shower area • Badewannen-Duschbereich • Zone de la baignoire/de douche • Área bañera/ducha • Зона ванны/душа • 浴缸/淋浴区域	page 334
Colonne doccia e soffioni doccia Shower bars and shower heads • Duschkombinationen und Kopfbrausen • Colones de douche et douches de tête • Columnas de ducha y rociadores de ducha • Колонны для душа и лейки для душа • 淋浴杆及莲蓬头	page 449
Complementi bagno Bathroom complements • Badkomplemente • Compléments bain • Complementos baño • Дополнительные компоненты для ванной комнаты • 浴室组件	page 683

70.1410.5

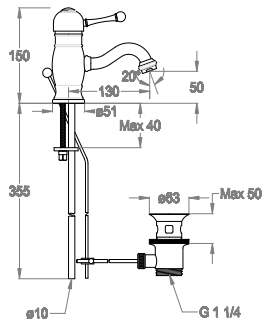

- Miscelatore lavabo h. 150 mm, interasse 130 mm, con scarico e salterello.
- Wash basin mixer, 150 mm high, center distance 130 mm long, with pop-up drain and pull-rod.
- Waschtisch-Einhebelmischer, Höhe 150 mm, Ausladung 130 mm, mit Ablaufgarnitur und Zugstange.
- Mitigeur de lavabo, hauteur 150 mm, entraxe 130 mm, avec vidage et tirette.
- Monomando de lavabo, altura 150 mm, distancia entre los ejes 130 mm, con desagüe y tirador completo.
- Смеситель для умывальника высотой 150 мм, межос.расстояние 130 мм, со сливом и донным клапаном.
- 面盆龙头, 150 mm高, 轴间距130 mm, 带提拉去水和拉杆。



FINITURA • FINISHING • FARBE • COULEUR • ACABADO • ОТДЕЛКА • 表面处理	CODICE • CODE • CODE • CODE • CÓDIGO • КОД • 代码
Chrome	70.1410.5.10.00
Chrome & Black Ceramic	70.1410.5.10.08
Chrome & Crystal	70.1410.5.10.51
Gold	70.1410.5.13.00
Gold & Crystal	70.1410.5.13.51
Antique Gold	70.1410.5.14.00
Antique Gold & Brown Ceramic	70.1410.5.14.09
Antique Gold & Crystal	70.1410.5.14.51
Gold Glam	70.1410.5.18.00
Gold Glam & Crystal	70.1410.5.18.51
Bronze	70.1410.5.22.00
Bronze & Crystal	70.1410.5.22.51

Area lavabo Wash basin area • Waschtisch-Bereich • Zone du lavabo • Área lavabo • Зона умывальника • 面盆区域	page 333
Area bidet/WC Bidet/WC area • Bidet/WC-Bereich • Zone du bidet/WC • Área bidé/WC • Зона биде/унитаз • 净身盆/厕所区域	page 333
Area vasca/doccia Bath/shower area • Badewannen-Duschbereich • Zone de la baignoire/de douche • Área bañera/ducha • Зона ванны/душа • 浴缸/淋浴区域	page 334
Colonne doccia e soffioni doccia Shower bars and shower heads • Duschkombinationen und Kopfbrausen • Colones de douche et douches de tête • Columnas de ducha y rociadores de ducha • Колонны для душа и лейки для душа • 淋浴杆及莲蓬头	page 449
Complementi bagno Bathroom complements • Badkomplemente • Compléments bain • Complementos baño • Дополнительные компоненты для ванной комнаты • 浴室组件	page 683

70.2410.5

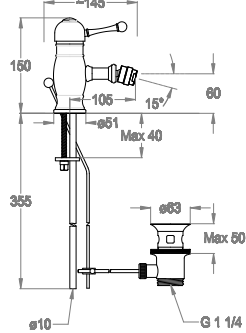

- Miscelatore bidet h. 150 mm, interasse 105 mm, con scarico e salterello.
- Bidet mixer, 150 mm high, center distance 105 mm long, with pop-up drain and pull-rod.
- Bidet-Einhebelmischer Höhe 150 mm, Ausladung 105 mm, mit Ablaufgarnitur und Zugstange.
- Mitigeur de bidet hauteur 150 mm, entraxe 105 mm, avec vidage et tirette.
- Monomando bidé altura 150 mm, distancia entre los ejes 105 mm, con desagüe y tirador completo.
- Смеситель для биде высотой 150 мм, межос.расстояние 105 мм, со сливом и донным клапаном.
- 净身盆龙头, 150 mm高, 轴间距105 mm, 带提拉去水和拉杆。



FINITURA • FINISHING • FARBE • COULEUR • ACABADO • ОТДЕЛКА • 表面处理	CODICE • CODE • CODE • CODE • CÓDIGO • КОД • 代码
Chrome	70.2410.5.10.00
Chrome & Black Ceramic	70.2410.5.10.08
Chrome & Crystal	70.2410.5.10.51
Gold	70.2410.5.13.00
Gold & Crystal	70.2410.5.13.51
Antique Gold	70.2410.5.14.00
Antique Gold & Brown Ceramic	70.2410.5.14.09
Antique Gold & Crystal	70.2410.5.14.51
Gold Glam	70.2410.5.18.00
Gold Glam & Crystal	70.2410.5.18.51
Bronze	70.2410.5.22.00
Bronze & Crystal	70.2410.5.22.51

Area lavabo Wash basin area • Waschtisch-Bereich • Zone du lavabo • Área lavabo • Зона умывальника • 面盆区域	page 333
Area bidet/WC Bidet/WC area • Bidet/WC-Bereich • Zone du bidet/WC • Área bidé/WC • Зона биде/унитаза • 净身盆/厕所区域	page 333
Area vasca/doccia Bath/shower area • Badewannen-Duschbereich • Zone de la baignoire/de douche • Área bañera/ducha • Зона ванны/душа • 浴缸/淋浴区域	page 334
Colonne doccia e soffioni doccia Shower bars and shower heads • Duschkombinationen und Kopfbrausen • Colonne de douche et douches de tête • Columnas de ducha y rociadores de ducha • Колонны для душа и лейки для душа • 淋浴杆及莲蓬头	page 449
Complementi bagno Bathroom complements • Badkomplemente • Compléments bain • Complementos baño • Дополнительные компоненты для ванной комнаты • 浴室组件	page 683

70.3313.2

- Miscelatore vasca esterno a parete con deviatore e doccetta duplex.
- Wall-mounted bath mixer with diverter and shower set.
- AP-Wannenfüll- und Brausearmatur mit Umstellventil und Brausegarnitur.
- Mitigeur bain/douche mural avec inverseur et ensemble douche.
- Mezclador monomando para baño/ducha mural con inversor y ducha de mano duplex.
- Смеситель наружный настенный для ванной с переключателем и душем дуплекс.
- 带分流阀和手持花洒的壁装式浴缸龙头。

FINITURA • FINISHING • FARBE • COULEUR • ACABADO • ОТДЕЛКА • 表面处理	CODICE • CODE • CODE • CODE • CÓDIGO • КОД • 代码
Chrome	70.3313.2.10.00
Chrome & Black Ceramic	70.3313.2.10.08
Chrome & Crystal	70.3313.2.10.51
Gold	70.3313.2.13.00
Gold & Crystal	70.3313.2.13.51
Antique Gold	70.3313.2.14.00
Antique Gold & Brown Ceramic	70.3313.2.14.09
Antique Gold & Crystal	70.3313.2.14.51
Gold Glam	70.3313.2.18.00
Gold Glam & Crystal	70.3313.2.18.51
Bronze	70.3313.2.22.00
Bronze & Crystal	70.3313.2.22.51

M 24x1 0540022 0590536 L=1500

70.3312.2

- Miscelatore vasca esterno a parete con deviatore e attacco flex.
- Wall-mounted bath mixer with diverter and flex hose connection.
- AP-Wannenfüll- und Brausearmatur mit Umstellventil und Verbindung für Brauseschlauch.
- Mitigeur bain/douche mural avec inverseur et raccord flexible.
- Mezclador monomando para baño/ducha mural con inversor y conexión flex.
- Смеситель наружный настенный для ванной с переключателем и гибким креплением.
- 带分流阀和软管接头的壁装式浴缸龙头。

FINITURA • FINISHING • FARBE • COULEUR • ACABADO • ОТДЕЛКА • 表面处理	CODICE • CODE • CODE • CODE • CÓDIGO • КОД • 代码
Chrome	70.3312.2.10.00
Chrome & Black Ceramic	70.3312.2.10.08
Chrome & Crystal	70.3312.2.10.51
Gold	70.3312.2.13.00
Gold & Crystal	70.3312.2.13.51
Antique Gold	70.3312.2.14.00
Antique Gold & Brown Ceramic	70.3312.2.14.09
Antique Gold & Crystal	70.3312.2.14.51
Gold Glam	70.3312.2.18.00
Gold Glam & Crystal	70.3312.2.18.51
Bronze	70.3312.2.22.00
Bronze & Crystal	70.3312.2.22.51

M 24x1 0590536

70.4755.2

- Gruppo bordo vasca a due fori al piano.
- Two-hole deck-mounted bath mixer.
- Zweiloch-Wannenrandarmatur.
- Mitigeur deux trous pour bord de baignoire.
- Monomando de encimera a dos agujeros.
- Комплект для установки на борту ванной с двумя отверстиями.
- 两孔台装式浴缸套装。

FINITURA • FINISHING • FARBE • COULEUR • ACABADO • ОТДЕЛКА • 表面处理	CODICE • CODE • CODE • CODE • CÓDIGO • КОД • 代码
Chrome	70.4755.2.10.00
Chrome & Black Ceramic	70.4755.2.10.08
Chrome & Crystal	70.4755.2.10.51
Gold	70.4755.2.13.00
Gold & Crystal	70.4755.2.13.51
Antique Gold	70.4755.2.14.00
Antique Gold & Brown Ceramic	70.4755.2.14.09
Antique Gold & Crystal	70.4755.2.14.51
Gold Glam	70.4755.2.18.00
Gold Glam & Crystal	70.4755.2.18.51
Bronze	70.4755.2.22.00
Bronze & Crystal	70.4755.2.22.51

M 24x1 0590536

70.4775.2

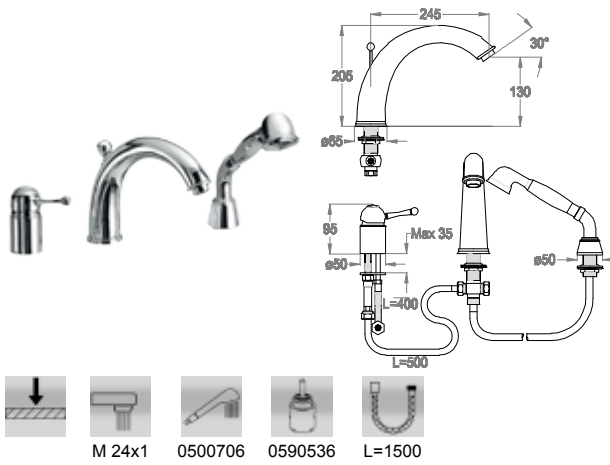

- Gruppo bordo vasca a tre fori al piano, con deviatore e doccetta duplex.
- Three-hole deck-mounted bath mixer with diverter and shower set.
- Dreiloch-Wannenrandarmatur, mit Umstellventil und Schlupfbrause.
- Mitigeur trois trous pour bord de baignoire avec inverseur et ensemble douche.
- Monomando de encimera a tres agujeros con inversor y ducha de mano duplex.
- Комплект для установки на борту ванной с тремя отверстиями, с переключателем и душем дуплекс.
- 带分流阀和手持花洒的三孔台装式浴缸套装。

FINITURA • FINISHING • FARBE • COULEUR • ACABADO • ОТДЕЛКА • 表面处理	CODICE • CODE • CODE • CODE • CODIGO • КОД • 代码
Chrome	70.4775.2.10.00
Chrome & Black Ceramic	70.4775.2.10.08
Chrome & Crystal	70.4775.2.10.51
Gold	70.4775.2.13.00
Gold & Crystal	70.4775.2.13.51
Antique Gold	70.4775.2.14.00
Antique Gold & Brown Ceramic	70.4775.2.14.09
Antique Gold & Crystal	70.4775.2.14.51
Gold Glam	70.4775.2.18.00
Gold Glam & Crystal	70.4775.2.18.51
Bronze	70.4775.2.22.00
Bronze & Crystal	70.4775.2.22.51

70.4765.2

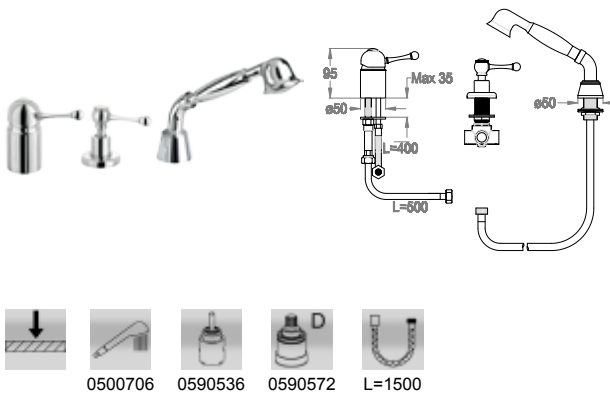

- Gruppo bordo vasca a tre fori al piano, con deviatore e doccetta duplex, senza bocca.
- Three-hole deck-mounted bath mixer with diverter and shower set, without spout.
- Dreiloch-Wannenrandarmatur mit Umstellventil und Schlupfbrause, ohne Auslauf.
- Mitigeur trois trous pour bord de baignoire avec inverseur et ensemble douche, sans bec.
- Monomando de encimera a tres agujeros con inversor y ducha de mano duplex, sin caño.
- Комплект для установки на борту ванной с тремя отверстиями, с переключателем и душем дуплекс, без излива.
- 带分流阀和手持花洒的三孔台装式浴缸套装，不含水嘴。

FINITURA • FINISHING • FARBE • COULEUR • ACABADO • ОТДЕЛКА • 表面处理	CODICE • CODE • CODE • CODE • CODIGO • КОД • 代码
Chrome	70.4765.2.10.00
Chrome & Black Ceramic	70.4765.2.10.08
Chrome & Crystal	70.4765.2.10.51
Gold	70.4765.2.13.00
Gold & Crystal	70.4765.2.13.51
Antique Gold	70.4765.2.14.00
Antique Gold & Brown Ceramic	70.4765.2.14.09
Antique Gold & Crystal	70.4765.2.14.51
Gold Glam	70.4765.2.18.00
Gold Glam & Crystal	70.4765.2.18.51
Bronze	70.4765.2.22.00
Bronze & Crystal	70.4765.2.22.51

05.0080.0

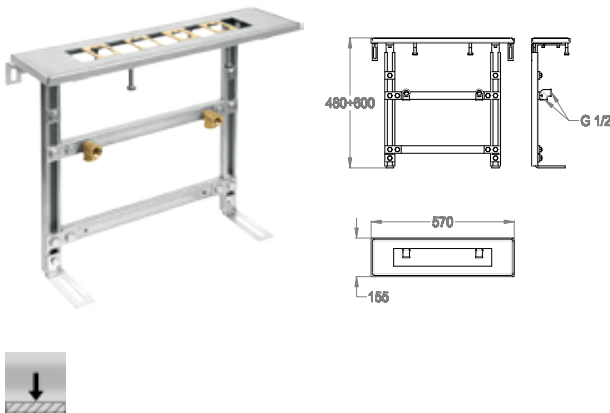

- Sistema di montaggio per bordo vasca con fissaggio a pavimento.
- Assembly system for deck-mounted bath mixer with floor fixing.
- Montagesystem für Wannenrand mit Befestigung am Boden.
- Système de montage pour bord de baignoire avec fixation au sol.
- Sistema de montaje para borde bañera con fijación en el suelo.
- Система установки на борту ванной с напольным креплением.
- 带地台固定的台装式浴缸龙头组装套件。

FINITURA • FINISHING • FARBE • COULEUR • ACABADO • ОТДЕЛКА • 表面处理	CODICE • CODE • CODE • CODE • CODIGO • КОД • 代码
Raw Brass	05.0080.0.05.00

05.0081.0

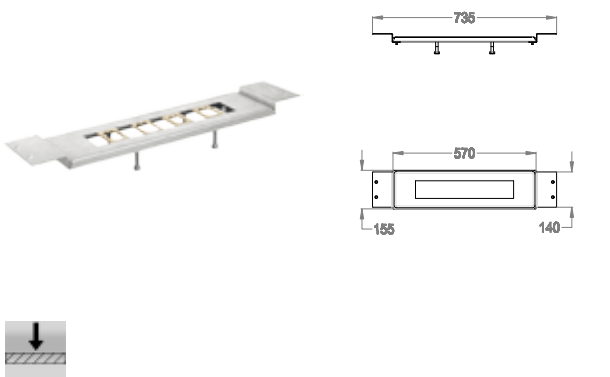

- Sistema di montaggio per bordo vasca con fissaggio al piano.
- Assembly system for deck-mounted bath mixer with deck fixing.
- Montagesystem für Wannenrand mit Befestigung am Rand.
- Système de montage pour bord de baignoire avec fixation sur plan.
- Sistema de montaje para borde bañera con fijación en la encimera.
- Система установки на борту ванной с настольным креплением.
- 带台上固定的台装式浴缸龙头组装套件。

FINITURA • FINISHING • FARBE • COULEUR • ACABADO • ОТДЕЛКА • 表面处理	CODICE • CODE • CODE • CODE • CODIGO • КОД • 代码
Raw Brass	05.0081.0.05.00

20.4614.3

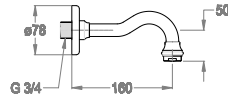

- Bocca di erogazione a parete, ingresso acqua 3/4", interasse 160 mm.
- Wall-mounted water spout 3/4", center distance 160 mm long.
- Wandauslauf 3/4", Ausladung 160 mm.
- Bec mural, arrivée d'eau 3/4", entraxe 160 mm.
- Caño mural, entrada agua 3/4", distancia entre los ejes 160 mm.
- Настенный излив, выпуск воды 3/4", межос.расстояние 160 мм.
- 壁装式水嘴3/4", 轴间距160 mm.

FINITURA • FINISHING • FARBE • COULEUR • ACABADO • ОТДЕЛКА • 表面处理	CODICE • CODE • CODE • CODE • CODIGO • КОД • 代码
Chrome	20.4614.3.10.00
Gold	20.4614.3.13.00
Antique Gold	20.4614.3.14.00
Gold Glam	20.4614.3.18.00
Bronze	20.4614.3.22.00

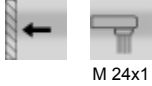

M 24x1

70.4570.2



- Parte esterna rubinetto incasso a parete HOT.
- External part for wall-mounted built-in straight stop HOT.
- Fertigmontageset zu Unterputzventil HOT.
- Partie extérieure pour robinet encastré HOT.
- Parte externa para llave de paso HOT.
- Наружная часть встроенного в стену крана HOT.
- 壁嵌式热水直旋塞阀的外露部件。

FINITURA • FINISHING • FARBE • COULEUR • ACABADO • ОТДЕЛКА • 表面处理	CODICE • CODE • CODE • CODE • CODIGO • КОД • 代码
Chrome	70.4570.2.10.00
Chrome & Black Ceramic	70.4570.2.10.08
Chrome & Crystal	70.4570.2.10.51
Gold	70.4570.2.13.00
Gold & Crystal	70.4570.2.13.51
Antique Gold	70.4570.2.14.00
Antique Gold & Brown Ceramic	70.4570.2.14.09
Antique Gold & Crystal	70.4570.2.14.51
Gold Glam	70.4570.2.18.00
Gold Glam & Crystal	70.4570.2.18.51
Bronze	70.4570.2.22.00
Bronze & Crystal	70.4570.2.22.51



Articoli complementari necessari
Necessary complementary items
Notwendige komplementäre Artikel
Articles complémentaires nécessaires
Artículos complementarios necesarios
Необходимые дополнительные предметы
必须的配套产品

05.2451.6



page 728

- Parte incasso rubinetto sinistro a parete.
- Built-in part for wall-mounted straight stop, left.
- UP-Einbaukörper zu Unterputzventil, links.
- Partie encastrée pour robinet mural, gauche.
- Parte empotrable para llave de paso, izquierda.
- Встроенная часть настенного левого крана.
- 壁嵌式左直旋塞阀的预埋件。

FINITURA • FINISHING • FARBE • COULEUR • ACABADO • ОТДЕЛКА • 表面处理	CODICE • CODE • CODE • CODE • CODIGO • КОД • 代码
Raw Brass	05.2451.6.05.00

70.4570.3



- Parte esterna rubinetto incasso a parete COLD.
- External part for wall-mounted built-in straight stop COLD.
- Fertigmontageset zu Unterputzventil COLD.
- Partie extérieure pour robinet encastré COLD.
- Parte externa para llave de paso COLD.
- Наружная часть встроенного в стену крана COLD.
- 壁嵌式冷水直旋塞阀的外露部件。

FINITURA • FINISHING • FARBE • COULEUR • ACABADO • ОТДЕЛКА • 表面处理	CODICE • CODE • CODE • CODE • CODIGO • КОД • 代码
Chrome	70.4570.3.10.00
Chrome & Black Ceramic	70.4570.3.10.08
Gold	70.4570.3.13.00
Antique Gold	70.4570.3.14.00
Antique Gold & Brown Ceramic	70.4570.3.14.09
Gold Glam	70.4570.3.18.00
Bronze	70.4570.3.22.00



Articoli complementari necessari
Necessary complementary items
Notwendige komplementäre Artikel
Articles complémentaires nécessaires
Artículos complementarios necesarios
Необходимые дополнительные предметы
必须的配套产品

05.2451.4



page 728

- Parte incasso rubinetto destro a parete.
- Built-in part for wall-mounted straight stop, right.
- UP-Einbaukörper zu Unterputzventil, rechts.
- Partie encastrée pour robinet mural, droit.
- Parte empotrable para llave de paso, derecha.
- Встроенная часть настенного правого крана.
- 壁嵌式右直旋塞阀的预埋件。

FINITURA • FINISHING • FARBE • COULEUR • ACABADO • ОТДЕЛКА • 表面处理	CODICE • CODE • CODE • CODE • CODIGO • КОД • 代码
Raw Brass	05.2451.4.05.00

➔ 20.9417.8

NEW

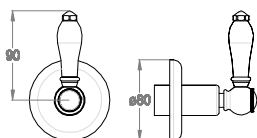

- Parte esterna deviatore incasso a parete.
- External part for wall-mounted built-in diverter.
- Fertigmontageset zu UP-Umstellventil.
- Partie extérieure pour inverseur encastré.
- Parte externa inversor empotrable mural.
- Наружная часть встроенного в стену переключателя.
- 壁嵌式分流阀的外露部件。



Articoli complementari necessari
Necessary complementary items
Notwendige komplementäre Artikel
Articles complémentaires nécessaires
Artículos complementarios necesarios
Необходимые дополнительные предметы
必须的配套产品

05.2459.2



page 730

- Parte incasso deviatore due uscite.
- Built-in part for two-way diverter valve.
- UP-Einbaukörper zu Zweibege-Umstellventil.
- Partie encastrée pour inverseur à deux sorties.
- Parte empotrable para inversor dos salidas.
- Встроенная часть двухходового переключателя.
- 两路分流阀的预埋件。

05.2459.3



page 730

- Parte incasso deviatore tre uscite.
- Built-in part for three-way diverter valve.
- UP-Einbaukörper zu Dreibege-Umstellventil.
- Partie encastrée pour inverseur à trois sorties.
- Parte empotrable para inversor tres salidas.
- Встроенная часть трехходового переключателя.
- 三路分流阀的预埋件。

FINITURA • FINISHING • FARBE • COULEUR • ACABADO • ОТДЕЛКА • 表面处理	CODICE • CODE • CODE • CODE • CODIGO • КОД • 代码
Chrome	20.9417.8.10.00
Chrome & Black Ceramic	20.9417.8.10.08
Chrome & Crystal	20.9417.8.10.51
Gold	20.9417.8.13.00
Gold & Crystal	20.9417.8.13.51
Antique Gold	20.9417.8.14.00
Antique Gold & Brown Ceramic	20.9417.8.14.09
Antique Gold & Crystal	20.9417.8.14.51
Gold Glam	20.9417.8.18.00
Gold Glam & Crystal	20.9417.8.18.51
Bronze	20.9417.8.22.00
Bronze & Crystal	20.9417.8.22.51

FINITURA • FINISHING • FARBE • COULEUR • ACABADO • ОТДЕЛКА • 表面处理	CODICE • CODE • CODE • CODE • CODIGO • КОД • 代码
Raw Brass	05.2459.2.05.00

FINITURA • FINISHING • FARBE • COULEUR • ACABADO • ОТДЕЛКА • 表面处理	CODICE • CODE • CODE • CODE • CODIGO • КОД • 代码
Raw Brass	05.2459.3.05.00

70.4210.2

! Nicht für deutschsprachige Märkte

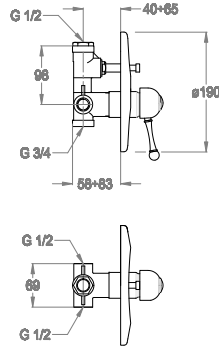

- Miscelatore vasca doccia incasso a parete.
- Built-in shower and bath mixer.
- UP-Wannenfüll- und Brausearmatur.
- Mitigeur bain/douche encastré.
- Mezclador monomando baño/ducha empotrable.
- Смеситель, встроенный в стену для ванной и душа.
- 壁嵌式淋浴和浴缸龙头。



FINITURA • FINISHING • FARBE • COULEUR • ACABADO • ОТДЕЛКА • 表面处理	CODICE • CODE • CODE • CODE • CODIGO • КОД • 代码
Chrome	70.4210.2.10.00
Chrome & Black Ceramic	70.4210.2.10.08
Chrome & Crystal	70.4210.2.10.51
Gold	70.4210.2.13.00
Gold & Crystal	70.4210.2.13.51
Antique Gold	70.4210.2.14.00
Antique Gold & Brown Ceramic	70.4210.2.14.09
Antique Gold & Crystal	70.4210.2.14.51
Gold Glam	70.4210.2.18.00
Gold Glam & Crystal	70.4210.2.18.51
Bronze	70.4210.2.22.00
Bronze & Crystal	70.4210.2.22.51

70.4270.2

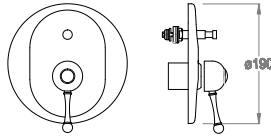

- Parte esterna miscelatore vasca doccia incasso a parete.
- External part for wall-mounted built-in shower and bath mixer.
- Fertigmontageset zu UP-Wannenfüll- und Brausearmatur.
- Partie extérieure pour mitigeur bain/douche encastré.
- Parte externa para mezclador monomando baño/ducha empotrable.
- Наружная часть встроенного в стену смесителя для ванной и душа.
- 壁嵌式淋浴和浴缸龙头的外露部件。



FINITURA • FINISHING • FARBE • COULEUR • ACABADO • ОТДЕЛКА • 表面处理	CODICE • CODE • CODE • CODE • CODIGO • КОД • 代码
Chrome	70.4270.2.10.00
Chrome & Black Ceramic	70.4270.2.10.08
Chrome & Crystal	70.4270.2.10.51
Gold	70.4270.2.13.00
Gold & Crystal	70.4270.2.13.51
Antique Gold	70.4270.2.14.00
Antique Gold & Brown Ceramic	70.4270.2.14.09
Antique Gold & Crystal	70.4270.2.14.51
Gold Glam	70.4270.2.18.00
Gold Glam & Crystal	70.4270.2.18.51
Bronze	70.4270.2.22.00
Bronze & Crystal	70.4270.2.22.51

Articoli complementari necessari
Necessary complementary items
Notwendige komplementäre Artikel
Articles complémentaires nécessaires
Artículos complementarios necesarios
Необходимые дополнительные предметы
必须的配套产品

05.2421.4



page 727

- Parte incasso miscelatore a due uscite.
- Built-in part for two-way mixer.
- UP-Einbaukörper für Zweiwege-Einhebelmischer.
- Partie encastrée pour mitigeur à deux sorties.
- Parte empotrable para mezclador monomando dos salidas.
- Встроенная часть двухходового смесителя.
- 双出水口龙头的预埋件。

FINITURA • FINISHING • FARBE • COULEUR • ACABADO • ОТДЕЛКА • 表面处理	CODICE • CODE • CODE • CODE • CODIGO • КОД • 代码
Raw Brass	05.2421.4.05.00

70.4310.2

! Nicht für deutschsprachige Märkte

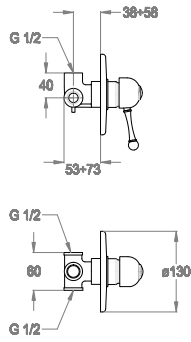

- Miscelatore doccia incasso a parete.
- Built-in shower mixer.
- UP-Brausearmatur.
- Mitigeur de douche encastré.
- Monomando ducha empotrable.
- Встроенный в стену смеситель для душа.
- 壁嵌式淋浴龙头。



FINITURA • FINISHING • FARBE • COULEUR • ACABADO • ОТДЕЛКА • 表面处理	CODICE • CODE • CODE • CODE • CODIGO • КОД • 代码
Chrome	70.4310.2.10.00
Chrome & Black Ceramic	70.4310.2.10.08
Chrome & Crystal	70.4310.2.10.51
Gold	70.4310.2.13.00
Gold & Crystal	70.4310.2.13.51
Antique Gold	70.4310.2.14.00
Antique Gold & Brown Ceramic	70.4310.2.14.09
Antique Gold & Crystal	70.4310.2.14.51
Gold Glam	70.4310.2.18.00
Gold Glam & Crystal	70.4310.2.18.51
Bronze	70.4310.2.22.00
Bronze & Crystal	70.4310.2.22.51

70.4370.2

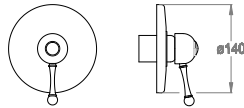

- Parte esterna miscelatore doccia incasso a parete.
- External part for built-in shower mixer.
- Fertigmontageset zu UP-Brausearmatur.
- Partie extérieure pour mitigeur de douche encastré.
- Parte externa para monomando empotrable.
- Наружная часть встроенного в стену смесителя для душа.
- 壁嵌式淋浴龙头的外露部件。



FINITURA • FINISHING • FARBE • COULEUR • ACABADO • ОТДЕЛКА • 表面处理	CODICE • CODE • CODE • CODE • CODIGO • КОД • 代码
Chrome	70.4370.2.10.00
Chrome & Black Ceramic	70.4370.2.10.08
Chrome & Crystal	70.4370.2.10.51
Gold	70.4370.2.13.00
Gold & Crystal	70.4370.2.13.51
Antique Gold	70.4370.2.14.00
Antique Gold & Brown Ceramic	70.4370.2.14.09
Antique Gold & Crystal	70.4370.2.14.51
Gold Glam	70.4370.2.18.00
Gold Glam & Crystal	70.4370.2.18.51
Bronze	70.4370.2.22.00
Bronze & Crystal	70.4370.2.22.51

Articoli complementari necessari
Necessary complementary items
Notwendige komplementäre Artikel
Articles complémentaires nécessaires
Artículos complementarios necesarios
Необходимые дополнительные предметы
必须的配套产品

05.2430.4



page 725

- Parte incasso miscelatore a parete ad una uscita.
- Built-in part for wall-mounted one-way mixer.
- UP-Einbaukörper für Einweg-Einhebelmischer.
- Partie encastrée pour mitigeur à une sortie.
- Parte empotrable mezclador monomando una salida.
- Встроенная часть одноходового смесителя.
- 壁装式单出水口龙头的预埋件。

FINITURA • FINISHING • FARBE • COULEUR • ACABADO • ОТДЕЛКА • 表面处理	CODICE • CODE • CODE • CODE • CODIGO • КОД • 代码
Raw Brass	05.2430.4.05.00

70.3363.2

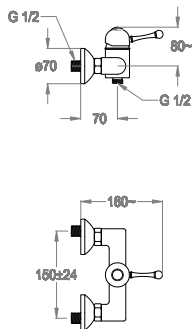

- Miscelatore doccia esterno a parete con attacco flex.
- Wall-mounted shower mixer with flex hose connection.
- AP-Brause-Einhebelmischer mit Verbindung für Brauseschlauch.
- Mitigeur de douche mural avec raccord flexible.
- Mezclador monomando ducha mural con conexión flex.
- Наружный настенный смеситель для душа с гибким креплением.
- 带软管接头的壁装式淋浴龙头。



FINITURA • FINISHING • FARBE • COULEUR • ACABADO • ОТДЕЛКА • 表面处理	CODICE • CODE • CODE • CODE • CODIGO • КОД • 代码
Chrome	70.3363.2.10.00
Chrome & Black Ceramic	70.3363.2.10.08
Chrome & Crystal	70.3363.2.10.51
Gold	70.3363.2.13.00
Gold & Crystal	70.3363.2.13.51
Antique Gold	70.3363.2.14.00
Antique Gold & Brown Ceramic	70.3363.2.14.09
Antique Gold & Crystal	70.3363.2.14.51
Gold Glam	70.3363.2.18.00
Gold Glam & Crystal	70.3363.2.18.51
Bronze	70.3363.2.22.00
Bronze & Crystal	70.3363.2.22.51

70.3355.2

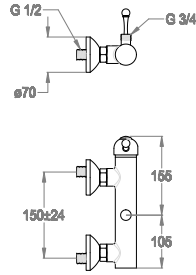

- Miscelatore doccia esterno a parete con attacco per colonna doccia esterna.
- Wall-mounted shower mixer with external shower bar connection.
- AP-Brause-Einhebelmischer mit Verbindung zur Duschkombination.
- Mitigeur de douche mural avec raccord pour colonne de douche externe.
- Mezclador monomando ducha mural con conexión para columna de ducha externa.
- Наружный настенный смеситель для душа с креплением к наружной колонне для душа.
- 带淋浴杆接头的壁装式淋浴龙头。



FINITURA • FINISHING • FARBE • COULEUR • ACABADO • ОТДЕЛКА • 表面处理	CODICE • CODE • CODE • CODE • CODIGO • КОД • 代码
Chrome	70.3355.2.10.00
Chrome & Black Ceramic	70.3355.2.10.08
Chrome & Crystal	70.3355.2.10.51
Gold	70.3355.2.13.00
Gold & Crystal	70.3355.2.13.51
Antique Gold	70.3355.2.14.00
Antique Gold & Brown Ceramic	70.3355.2.14.09
Antique Gold & Crystal	70.3355.2.14.51
Bronze	70.3355.2.22.00
Bronze & Crystal	70.3355.2.22.51

20.4230.2

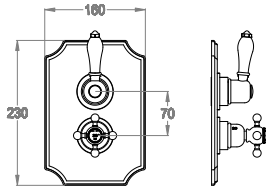

- Parte esterna miscelatore doccia incasso termostatico a parete con rubinetto d'arresto.
- External part for wall-mounted built-in thermostatic shower mixer with stop valve.
- Fertigmontageset zu UP-Brausethermostat mit Absperrventil.
- Partie extérieure pour mitigeur de douche thermostatique encastré avec robinet d'arrêt.
- Parte externa mezclador ducha empotrable termostático con llave de paso.
- Наружная часть встроенного в стену термостатического смесителя для душа с краном отключения.
- 带截止阀的壁嵌式恒温淋浴龙头的外露部件。

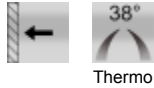

Thermo

FINITURA • FINISHING • FARBE • COULEUR • ACABADO • ОТДЕЛКА • 表面处理	CODICE • CODE • CODE • CODE • CODIGO • КОД • 代码
Chrome	20.4230.2.10.00
Chrome & Black Ceramic	20.4230.2.10.08
Chrome & Crystal	20.4230.2.10.51
Gold	20.4230.2.13.00
Gold & Crystal	20.4230.2.13.51
Antique Gold	20.4230.2.14.00
Antique Gold & Brown Ceramic	20.4230.2.14.09
Antique Gold & Crystal	20.4230.2.14.51
Gold Glam	20.4230.2.18.00
Gold Glam & Crystal	20.4230.2.18.51
Bronze	20.4230.2.22.00
Bronze & Crystal	20.4230.2.22.51

Articoli complementari necessari
Necessary complementary items
Notwendige komplementäre Artikel
Articles complémentaires nécessaires
Artículos complementarios necesarios
Необходимые дополнительные предметы
必须的配套产品

05.2447.0



page 731

- Parte incasso miscelatore termostatico a parete, con rubinetto d'arresto.
- Built-in part for wall-mounted thermostatic mixer, with stop valve.
- UP-Einbaukörper zu Brausethermostat mit Absperrventil.
- Partie encastrée pour mitigeur thermostatique mural, avec robinet d'arrêt.
- Parte empotrable mezclador termostático mural, con llave de paso.
- Встроенная часть термостатического настенного смесителя, с краном отключения.
- 带截止阀的壁装式恒温淋浴龙头的预埋件。

FINITURA • FINISHING • FARBE • COULEUR • ACABADO • ОТДЕЛКА • 表面处理	CODICE • CODE • CODE • CODE • CODIGO • КОД • 代码
Raw Brass	05.2447.0.05.00

➤ 20.4250.2

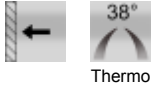
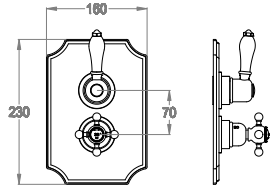

Articoli complementari necessari
Necessary complementary items
Notwendige komplementäre Artikel
Articles complémentaires nécessaires
Artículos complementarios necesarios
Необходимые дополнительные предметы
必须的配套产品

05.2447.2



page 731

- Parte esterna miscelatore doccia incasso termostatico a parete con rubinetto d'arresto e deviatore a due uscite.
- External part for wall-mounted built-in thermostatic shower mixer with stop valve and two-way diverter.
- Fertigmontageset zu UP-Brausethermostat mit Absperrventil und Zweizeige-Umstellventil.
- Partie extérieure pour mitigeur de douche thermostatique encastré avec robinet d'arrêt et inverseur à deux sorties.
- Parte externa mezclador ducha empotrable termostático con llave de paso y inversor de dos salidas.
- Наружная часть встроенного в стену терmostатического смесителя для душа с краном отключения и двухходовым переключателем.
- 外露部件，用于带截止阀和两路分流阀的壁嵌式恒温淋浴龙头。

FINITURA • FINISHING • FARBE • COULEUR • ACABADO • ОТДЕЛКА • 表面处理	CODICE • CODE • CODE • CODE • CODIGO • КОД • 代码
Chrome	20.4250.2.10.00
Chrome & Black Ceramic	20.4250.2.10.08
Chrome & Crystal	20.4250.2.10.51
Gold	20.4250.2.13.00
Gold & Crystal	20.4250.2.13.51
Antique Gold	20.4250.2.14.00
Antique Gold & Brown Ceramic	20.4250.2.14.09
Antique Gold & Crystal	20.4250.2.14.51
Gold Glam	20.4250.2.18.00
Gold Glam & Crystal	20.4250.2.18.51
Bronze	20.4250.2.22.00
Bronze & Crystal	20.4250.2.22.51

➤ 20.4250.3

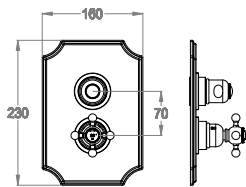

Articoli complementari necessari
Necessary complementary items
Notwendige komplementäre Artikel
Articles complémentaires nécessaires
Artículos complementarios necesarios
Необходимые дополнительные предметы
必须的配套产品

05.2447.3



page 732

- Parte esterna miscelatore doccia incasso termostatico a parete con rubinetto d'arresto e deviatore a tre uscite.
- External part for wall-mounted built-in thermostatic shower mixer with stop valve and three-way diverter.
- Fertigmontageset zu UP-Brausethermostat mit Absperrventil und Dreizeige-Umstellventil.
- Partie extérieure pour mitigeur de douche thermostatique encastré avec robinet d'arrêt et inverseur à trois sorties.
- Parte externa mezclador ducha empotrable termostático con llave de paso y inversor de tres salidas.
- Наружная часть встроенного в стену терmostатического смесителя для душа с краном отключения и трехходовым переключателем.
- 外露部件，用于带截止阀和三路分流阀的壁嵌式恒温淋浴龙头。

FINITURA • FINISHING • FARBE • COULEUR • ACABADO • ОТДЕЛКА • 表面处理	CODICE • CODE • CODE • CODE • CODIGO • КОД • 代码
Chrome	20.4250.3.10.00
Chrome & Black Ceramic	20.4250.3.10.08
Chrome & Crystal	20.4250.3.10.51
Gold	20.4250.3.13.00
Gold & Crystal	20.4250.3.13.51
Antique Gold	20.4250.3.14.00
Antique Gold & Brown Ceramic	20.4250.3.14.09
Antique Gold & Crystal	20.4250.3.14.51
Gold Glam	20.4250.3.18.00
Gold Glam & Crystal	20.4250.3.18.51
Bronze	20.4250.3.22.00
Bronze & Crystal	20.4250.3.22.51

FINITURA • FINISHING • FARBE • COULEUR • ACABADO • ОТДЕЛКА • 表面处理	CODICE • CODE • CODE • CODE • CODIGO • КОД • 代码
Raw Brass	05.2447.3.05.00

- Parte incasso miscelatore termostatico a parete, con rubinetto d'arresto e deviatore a tre uscite.
- Built-in part for wall-mounted thermostatic shower mixer, with stop valve and three-way diverter.
- UP-Einbaukörper zu Brausethermostat mit Absperr- und Dreizeige-Umstellventil.
- Partie encastrée pour mitigeur thermostatique mural, avec robinet d'arrêt et inverseur à trois sorties.
- Parte empotrable mezclador termostático mural, con llave de paso y inversor de tres salidas.
- Встроенная часть терmostатического настенного смесителя, с краном отключения и трехходовым переключателем.
- 预埋件，用于带截止阀和三路分流阀的壁嵌式恒温淋浴龙头。

22.3912.2

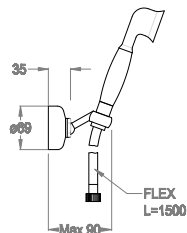

- Doccetta duplex a parete.
- Wall-mounted hand shower.
- Brausegarnitur.
- Ensemble douche.
- Ducha de mano duplex.
- Настенный душ дуплекс.
- 壁装式手持花洒。

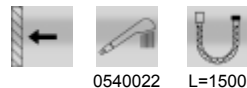

0540022 L=1500

FINITURA • FINISHING • FARBE • COULEUR • ACABADO • ОТДЕЛКА • 表面处理	CODICE • CODE • CODE • CODE • CODIGO • КОД • 代码
Chrome	22.3912.2.10.00
Gold	22.3912.2.13.00
Antique Gold	22.3912.2.14.00
Gold Glam	22.3912.2.18.00
Bronze	22.3912.2.22.00

22.3962.2

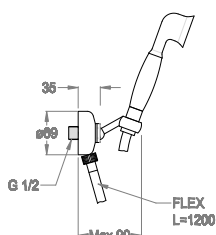

- Doccetta duplex incasso a parete con presa acqua.
- Built-in hand shower set with wall water inlet.
- Brausegarnitur zur Wandmontage mit integriertem Wasseranschluss.
- Ensemble douche encastré avec arrivée d'eau.
- Ducha de mano duplex empotrable con toma de agua.
- Настенный душ дуплекс с забором воды.
- 带墙进水的壁装式手持花洒。



G 1/2 0540022 L=1200

FINITURA • FINISHING • FARBE • COULEUR • ACABADO • ОТДЕЛКА • 表面处理	CODICE • CODE • CODE • CODE • CODIGO • КОД • 代码
Chrome	22.3962.2.10.00
Gold	22.3962.2.13.00
Antique Gold	22.3962.2.14.00
Gold Glam	22.3962.2.18.00
Bronze	22.3962.2.22.00

14.0099.5

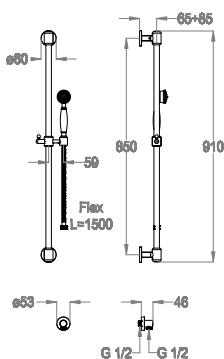

- Asta a parete con doccetta duplex, flex e presa d'acqua.
- Vertical bar with hand shower, flex and wall water inlet.
- Wandgleitstange mit Handbrause, Schlauch und Wasseranschluss.
- Barre murale avec douchette à main, flexible et arrivée d'eau.
- Barra mural con ducha de mano duplex, flex y toma de agua.
- Стенная штанга с душем дуплекс, гибкий шланг и водозабор.
- 垂直滑杆连手持花洒、软管及壁上进水口。



0540022 L=1500

FINITURA • FINISHING • FARBE • COULEUR • ACABADO • ОТДЕЛКА • 表面处理	CODICE • CODE • CODE • CODE • CODIGO • КОД • 代码
Chrome	14.0099.5.10.00
Gold	14.0099.5.13.00
Antique Gold	14.0099.5.14.00
Bronze	14.0099.5.22.00

➤ 14.0099.0



- Asta a parete.
- Vertical bar.
- Wandgleitstange.
- Barre murale.
- Barra mural.
- Стенная штанга.
- 垂直滑杆。

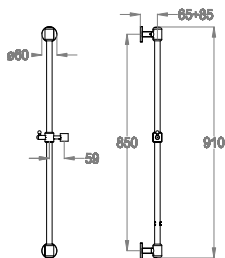

FINITURA • FINISHING • FARBE • COULEUR • ACABADO • ОТДЕЛКА • 表面处理	CODICE • CODE • CODE • CODE • CODIGO • КОД • 代码
Chrome	14.0099.0.10.00
Gold	14.0099.0.13.00
Antique Gold	14.0099.0.14.00
Bronze	14.0099.0.22.00



➤ 05.4002.2

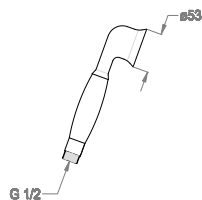

- Doccetta.
- Hand shower.
- Handbrause.
- Douchette.
- Ducha de mano.
- Душевая лейка.
- 手持花洒。

FINITURA • FINISHING • FARBE • COULEUR • ACABADO • ОТДЕЛКА • 表面处理	CODICE • CODE • CODE • CODE • CODIGO • КОД • 代码
Chrome	05.4002.2.10.00
Gold	05.4002.2.13.00
Antique Gold	05.4002.2.14.00
Gold Glam	05.4002.2.18.00
Bronze	05.4002.2.22.00

➤ 05.0001.2

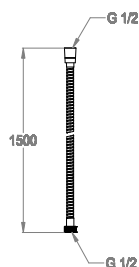

- Flessibile 1500 mm.
- 1500 mm hose.
- Brauseschlauch 1500 mm.
- Flexible 1500 mm.
- Flexible 1500 mm.
- Шланг 1500 мм.
- 1500 mm 软管。

FINITURA • FINISHING • FARBE • COULEUR • ACABADO • ОТДЕЛКА • 表面处理	CODICE • CODE • CODE • CODE • CODIGO • КОД • 代码
Chrome	05.0001.2.10.00
Gold	05.0001.2.13.00
Antique Gold	05.0001.2.14.00
Gold Glam	05.0001.2.18.00
Bronze	05.0001.2.22.00



L=1500

05.5006.2

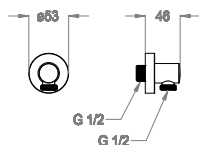

- Attacco erogazione.
- Wall water inlet.
- Wandanschlussbogen.
- Prise d'eau.
- Empalme suministro.
- Крепление излива.
- 墙进水。

FINITURA • FINISHING • FARBE • COULEUR • ACABADO • ОТДЕЛКА • 表面处理	CODICE • CODE • CODE • CODE • CODIGO • КОД • 代码
Chrome	05.5006.2.10.00
Gold	05.5006.2.13.00
Antique Gold	05.5006.2.14.00
Bronze	05.5006.2.22.00

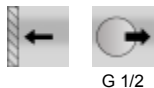

G 1/2

14.0096.5

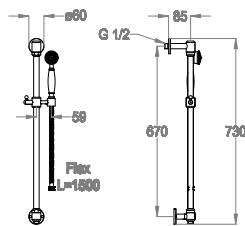

- Asta a parete con doccia duplex, flex e presa acqua in alto (ottimale per ristrutturazione).
- Vertical bar with hand shower, flex and water inlet in the upper part (suitable for renovation).
- Wandgleitstange mit Handbrause, Schlauch und Wasseranschluss oben (ideal für Badrenovierungen).
- Barre murale avec douchette à main, flexible et arrivée d'eau par le haut (idéale en rénovation).
- Barra mural con ducha de mano duplex, flex y toma de agua arriba (ideal para reformas).
- Стенная штанга с душем дуплекс, гибкий шланг и верхний водозабор (оптимально для ремонта).
- 垂直滑杆连手持花洒、软管及位于上部的进水口 (适合改造)。

FINITURA • FINISHING • FARBE • COULEUR • ACABADO • ОТДЕЛКА • 表面处理	CODICE • CODE • CODE • CODE • CODIGO • КОД • 代码
Chrome	14.0096.5.10.00
Gold	14.0096.5.13.00
Antique Gold	14.0096.5.14.00
Bronze	14.0096.5.22.00

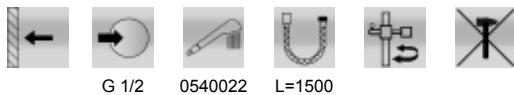

G 1/2 0540022 L=1500